

Kall,  
by Kettal Studio

**kettal**

# Kall

Designer  
Kettal Studio

Collection  
Kall

Kall is a new 'Phonebooth' that prioritizes privacy and aesthetics. The design features a glass door as the main feature, with small side walls and a translucent curtain to create privacy without sacrificing transparency. The focus is on creating a warm and pleasant atmosphere, with attention paid to the environmental and aesthetic aspects of the product.

The technology is integrated into the product in a subtle way, with everything electronically controlled, including scene creation systems, table height adjustment, ventilation control, and connectivity. The aim is to provide a simple and enjoyable user experience, with the option for more tech-savvy users to use a touch screen control system.



# Kall M

Designer  
Kettal Studio

Collection  
Kall



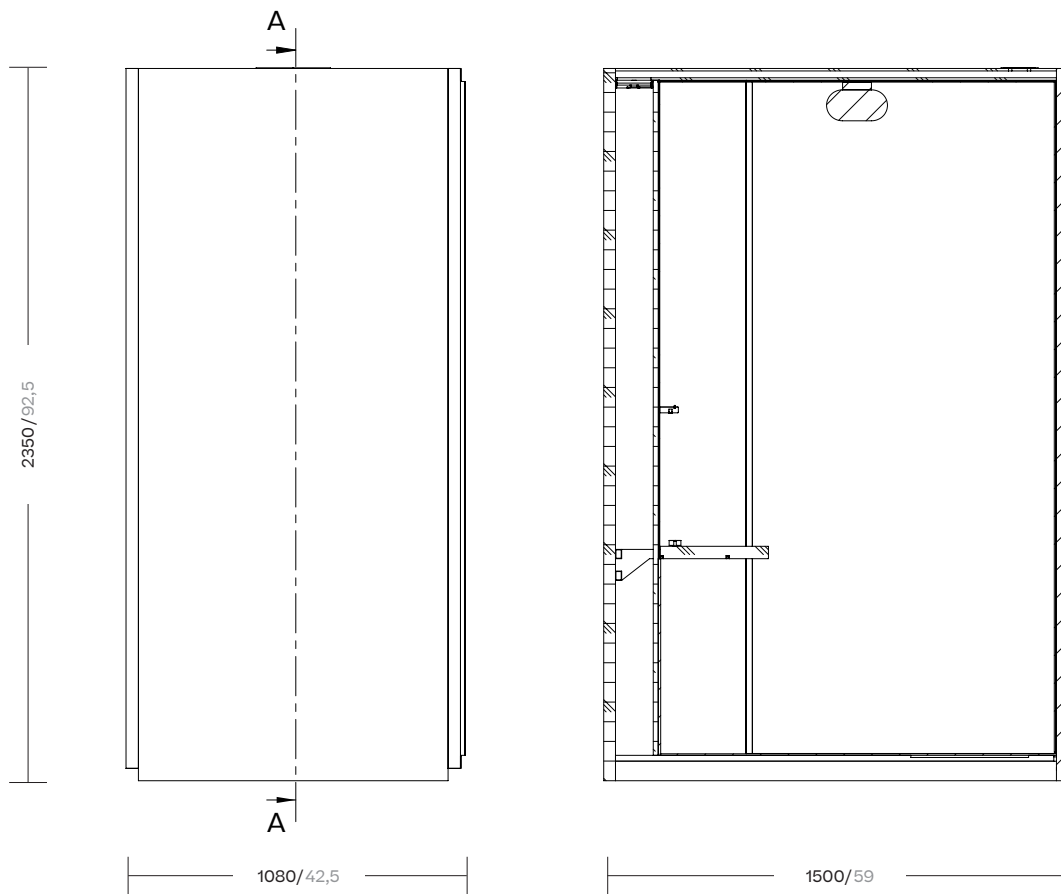

## Description

Kall in a wider dimension that accommodates a swivel armchair. Ideal for meetings in a more relaxed working posture. The exceptional acoustics and physical comfort allow for better communication, as well as concentration.

## Specifications

- Glazed door
- Pivot door
- Wooden frame
- Acoustic panels
- Absorption system
- Leveling feet
- USB A+C
- Wheels
- Curtains (Opt.)
- Faced external wall
- Air ventilation system
- LED lighting
- PIR sensor
- Integrated swivel armchair
- Regulable Integrated table (Opt.)

# Kall M

## Dimensions

Designer  
Kettal Studio

Collection  
Kall

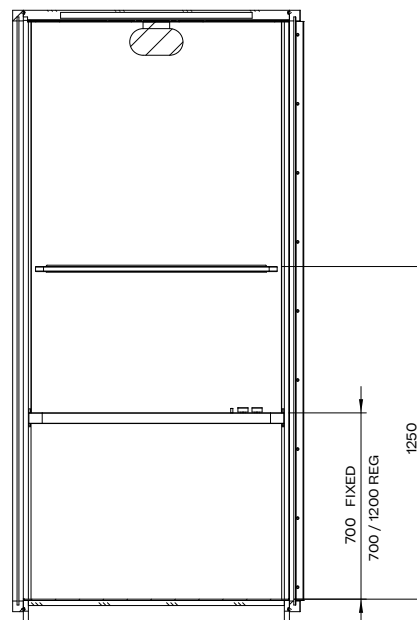
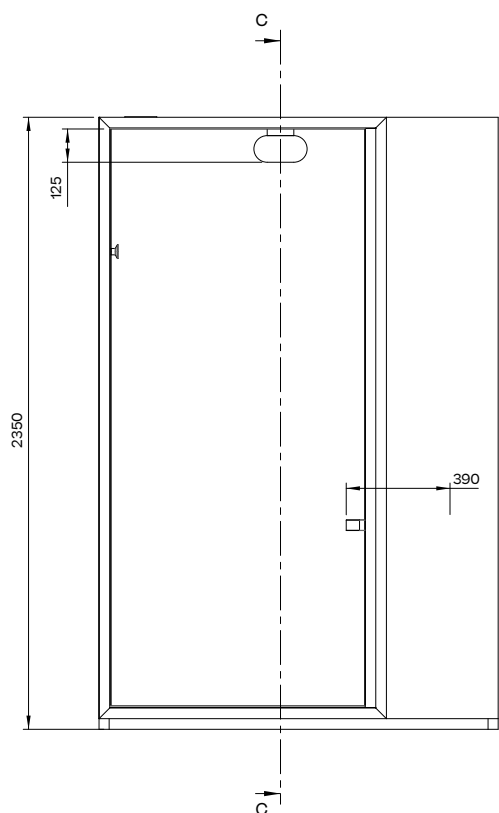

SECTION C-C  
SCALE 1 : 20

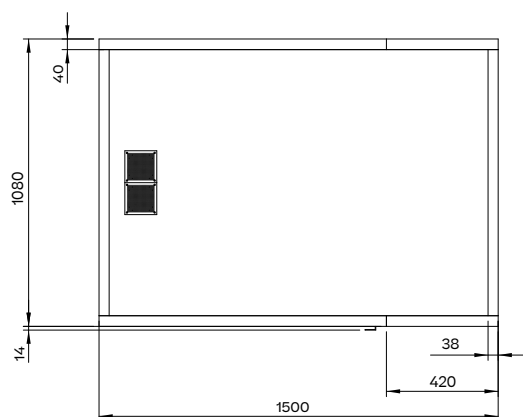

Dimensions (mm/inch)

Exterior - Interior

Height	2350 / 90,5 - 2170 / 85,4
Width	1500 / 59 - 1270 / 50
Depth	1080 / 42,5 - 1040 / 40,9
Tabletop (h x w x d)	700 x 960 x 390 / 26,4 x 37,8 x 15,3
Shelving	1450 x 910 x 60 / 57 x 35,8 x 23,6

# Kall M Features

Designer  
Kettal Studio

Collection  
Kall



LED Lighting with PIR sensor & regulable



Wheels for an easy transport



Leveling feet



Sustainably Soundproof



Integrated Desk (adjustable)



Integrated stool (adjustable)



Silent ventilation system



Plug & Play 100-240 V + USB A + USB C



More accessories: Shelf, hanger...



PIR sensor



Fast Assembly



Modularity



UL Recognized



CE Certified

# Kall M Features

Designer  
Kettal Studio

Collection  
Kall

## Silent Ventilation



The air enters through the floor (back of the stool) and comes out through the gap of each side of the table panel (1 cm of space) that is used to raise and lower the table.  
The cabin has a flow rate of 115m<sup>3</sup>/h (32 l/s) 60 air changes/hour inside. The nominal flow rate of the fans is 120m<sup>3</sup>/h.

## Integrated wheels and Leveling feet

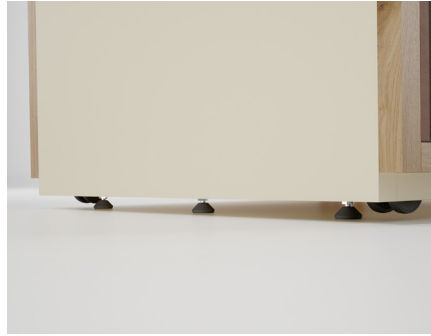

To ensure the stability of the cabin, the position of the regulator feet should be adjusted to raise the wheels. This procedure can be performed using a wrench, as the regulator feet have a nut that allows for adjustment. To move the cabin, it is necessary to raise the regulator feet again.

## Sustainably Soundproof

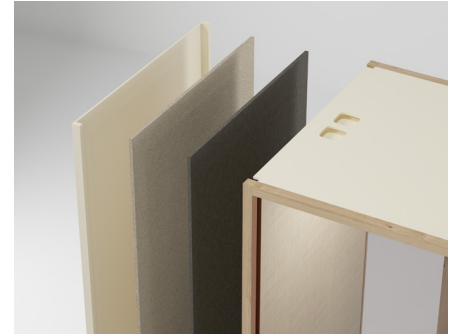

Class B, according ISO 23351-1  
Test: 28,9 dB (D<sub>SA</sub>)  
Acoustic glass panels 3+3 with 35 dB.  
Wood panel + PET + Foamed fabric.

Test Report



## Analog Controller



Adjustable table (Opt.). Plug USB-A / USB-C / shelf light dimmer, fans power regulator and desk height regulator



Non-adjustable table. Plug USB-A / USB-C / shelf light dimmer, fans power regulator



Control by screen. (Optional) Kern Screen / USB-A / USB-C

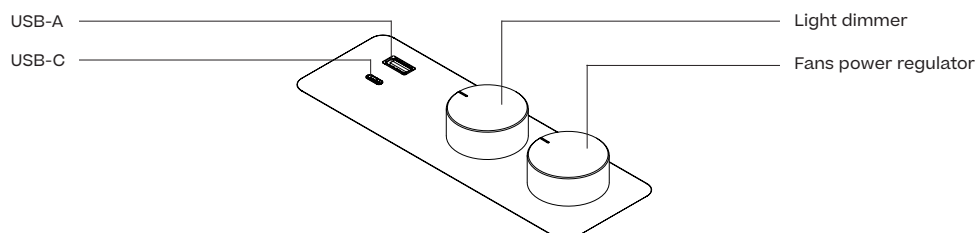

# Kall M Features

Designer  
Kettal Studio

Collection  
Kall

## LED Ceiling Light



**LED Ceiling Light**  
3000K (Dimmable)  
Ambient Lighting

## LED Shelf Light



**LED Shelf Light**  
3000K (Dimmable)  
Task Lighting

## Adjustable Desk



The table height is adjustable by the cylindrical switch on the controller.

It can be adjusted from 700 to 1200 mm in height. When non-adjustable height is 1100mm.

It supports a maximum weight of 100 kg.

## Swivel armchair



This versatile piece of furniture provides a comfortable and stylish seating option that can be easily adjusted to face any direction. With its sleek design and smooth rotation, the Swivel Armchair is ideal for comfortable meetings.

 Not included

## Shelf



To support your iPad, mobile phone, or complete the space with a picture or different decorative elements.

## PIR Sensor



Located under the Analog Controller.

The described system operates in three main states: in the idle state, the cabin's lights and fans are off; when occupied, the PIR sensor triggers the cabin's lights and fans, with levels set by corresponding potentiometers (ranging from 10% to 100%); when unoccupied, the lights and fans remain on, turning off after an adjustable period (3 to 60 minutes) set by an internal potentiometer on the CPU PCB, which is not user-accessible.



# Kall M Features

Designer  
Kettal Studio

Collection  
Kall

## Hanger / Coat rack



A hanger to hang your coat, purse, or other garments and keep your workspace clear.

## Curtains



Curtains provide privacy and give a more aesthetic and personalized look to the cabin.

## Modularity

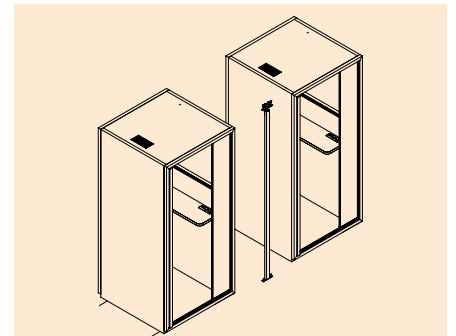

Our Kall booths can be combined in different ways to create work environments according to the needs of each user and adapt to different types of space.

## Plug & Play



The booth can be connected either from the ceiling or the floor, according to the customer's preference. You will simply need to connect the cable to the ceiling or the floor.

## Fast Assembly

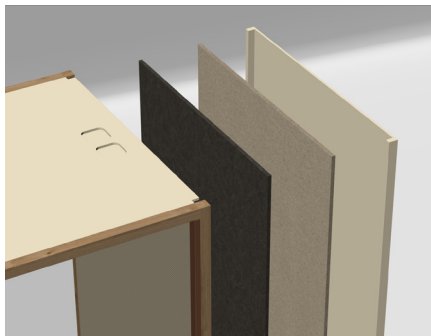

This product can be assembled in 90 minutes.

## CE Certified & UL Recognized

This product is designed in accordance with European regulations (CE) and UL listed (USA).

## Environmental Product Declaration

Scan this QR code to view the EPD report and the results of the Kall Booth family.



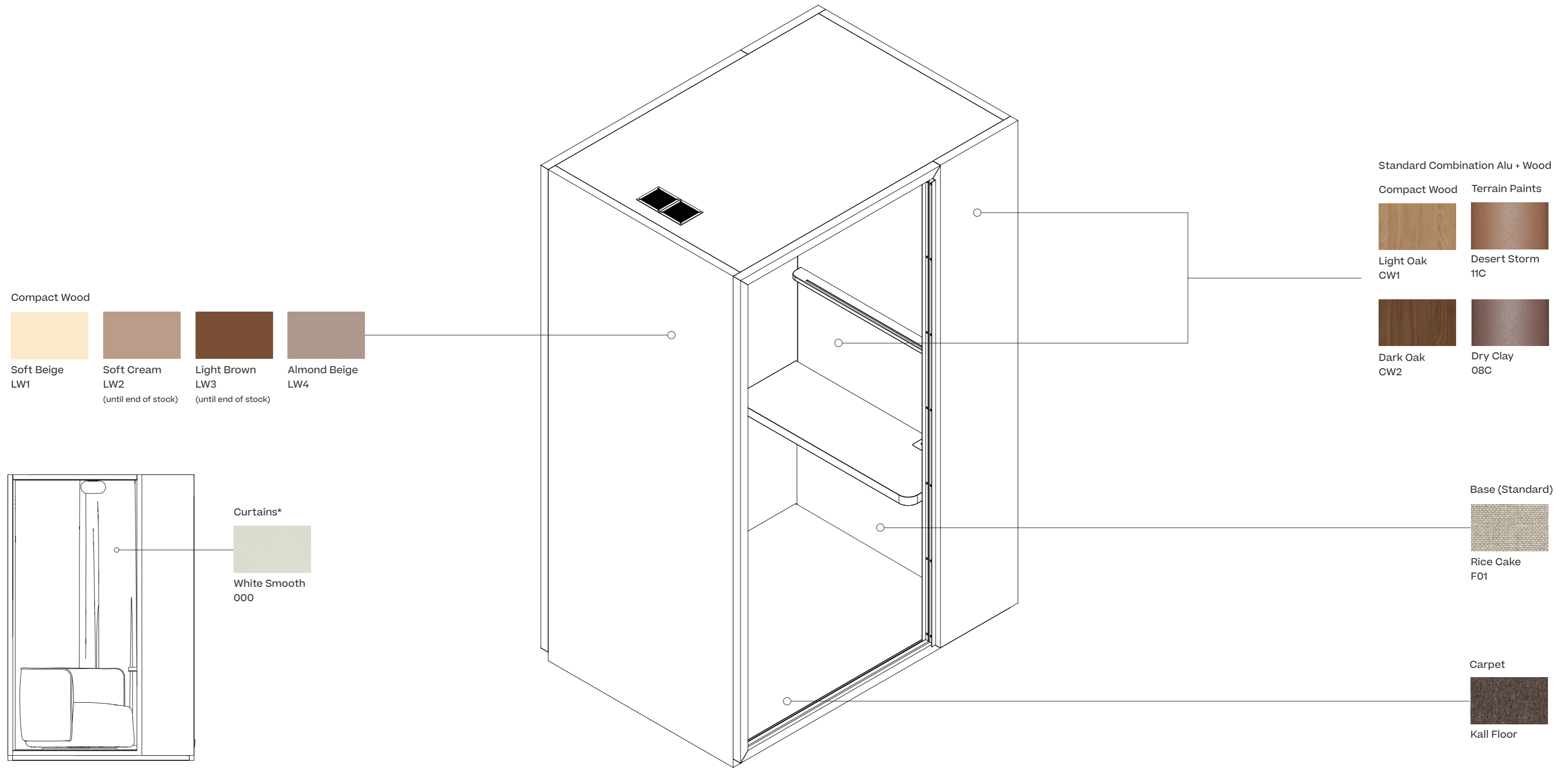

## Input (As a whole)

---

Nominal Input Voltage	90 - 305 VAC
Maximum Input Power	150W
Inter-element Power Supply	24VDC

USB A Connector 5VDC @ 2A @ 10W

USB C Connector 5VDC, 9VDC, 15VDC, 20VDC @ 3A @ 60W USB Type C 2.0 & USB PD 3.0

## PIR Operation

---

- In the idle state, the cabin's lights and fans are off.
- When occupied, the PIR sensor activates the cabin's lights and fans, whose levels are set by the corresponding potentiometers (both ranging from 10% to 100%).
- When unoccupied, the lights and fans remain on, turning off after an adjustable period (3 to 60 minutes) set by an internal potentiometer on the CPU PCB, not user-accessible.

Kall,  
Aesthetics & Materiality

**kettal**

## Description

Electrostatic powder coating process applied. This paint mixes a specific resin that offers greater hardness compared to the paints used in architecture. Terrain Paints are designed to coat aluminium profiles used in architecture and for other substrates where the maximum resistance to the outdoors is needed. This is a powder coating formulated with polyester resins and free of TGIC, pigments, and additives. These provide excellent exterior durability with very good gloss retention and colour stability.

Polymerization  
at 160 °C



Local supplier



Class A2

## Scratch test

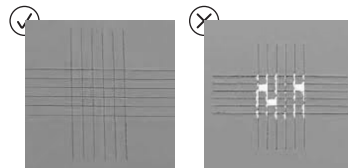

1x1 mm

## Impact test

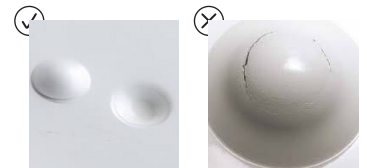

Characteristics	Min.	Max.	Method
Baking time / temperature	24 to 150 °C / 75,2 to 302 °F	26 to 150 °C / 78,8 to 302 °F	Total time
Gloss at 60° angle	6	9	ISO 2813
Direct impact 12.5 mm	30		ISO 2813
Indirect impact 12.5 mm	30		ISO 2813
Cross-cut adhesion	0	0	ISO 2813
Erichsen Cupping test	5	11	ISO 2813
Bend test (Cylindrical Mandrel)		6	ISO 2813
Avg. Particle size	50	55	MALVERN
Particle size % < 100 MICRONS	80	95	MALVERN
Particle size % < 50 MICRONS	50	65	MALVERN
Particle size % < 10 MICRONS	4	8	MALVERN
Delta E colour		VISUAL	CIELAB
General appearance	Textured		NIZI-001

## Door Frame Color



Desert Storm  
11C



Dry Clay  
08C

## Certificates



## Note

We recommend following the advice given by the standards AAMA 609 and 610-02 or in the guidelines from Qualicoat.

## Recommendations

1. Wash the surface periodically with warm water and soap, or a pH-neutral detergent.
2. Use a non-abrasive sponge or cloth.
3. Rinse immediately with a large amount of water after cleaning.
4. Cleaning should preferably be carried out in the shade and avoid extremely hot or cold temperatures.  
For cleaning grease, oils, cutting oils, adhesives, etc. we recommend using isopropyl alcohol in combination with turpentine, using a soft cloth. We recommend carrying out a test in an inconspicuous area to verify that the use of unknown mixtures does not affect the surface.

## Maintenance

Situation	Min periodic cleaning
Tropical	9 months
Swimming pools & gymnasiums	6 months
Coastal	3 months
Industrial	3 months
Hazardous	1 month
Normal	12 months

Clean with non-corrosive, non-abrasive products. Do not use scouring pads and pressure washers should not be used.

Depending on temperature and concentration, various highly acidic or alkaline materials can damage or attack the surface after only a few minutes.

Depending on temperature and concentration, various highly acidic or alkaline materials can damage or attack the surface after only a few minutes of contact. It is extremely important to take measures to avoid this.

### Preventative care

Protect surfaces with barrier elements like film, paper, and peelable lacquers before placement and handling.

### Immediate cleaning

If accidental contamination or splashing of strong alkalis or acids occurs, wash the affected area with a large amount of clean water, especially cut-outs or holes and cavities.

### Periodic maintenance

The accumulation of dirt or contamination on the profiles may increase the risk of corrosion, a loss of sheen, or a change of colour, especially in areas located near the coast and industrial environments.

### Do not use

Abrasive materials or tools or anything that could cause scratches. Acidic or alkaline substances that could cause corrosion. Strong solvents, including petrol, diesel, and kerosene. Grease cleaners, pesticides, or lubricants whose composition is unknown. Detergents, oven cleaners, or other similar agents. Cleaning agents when the surface temperature is greater than 25°C. Dry cleaning a dirty surface of dust or building materials.

Avoid submersing a powder coated product in water for long periods of time. Chlorine might cause damage.

## Compact Wood

Compact wood imitates the appearance of natural wood but offers superior mechanical properties. This material is used for the outer panels of our Kall booths and Pavilion O panels.



Suitable for indoor use only

## Technical specifications

Resistance to surface wear (N)	≥ 150 EN 438-2
Resistance to scratching	Smooth finishes: 2 / Texture finishes: 3
Thickness (mm)	6,5
Resistance to water vapour	4 EN 438-2
Resistance to staining	5 EN 438-2
Lightfastness (Xenon arc lamp)	4 to 5 EN 438-2
Reaction to fire	D-s2, d0 Class EN 13501-1

## Colors



Light Oak  
CW1

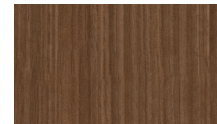

Dark Oak  
CW2

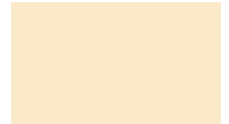

Soft Beige  
LW1



Sof Cream  
LW2  
(until end of stock)



Light Brown  
LW3  
(until end of stock)



Almond Beige  
LW4





## Base

---

Base fabric is specially crafted for indoor furniture upholstery and cushions. The material features a sophisticated palette, ranging from warm browns to cool greys, providing a stylish and versatile option for enhancing your indoor spaces.



Suitable for indoor use only

## Care instructions

---



## Technical specifications

---

Composition	100% Polyester Trade Mark Trevira CS
Weight (g/m <sup>2</sup> )	250
Abrasion resistance (Martindale) 7	0.000 rubs ISO 12947-2
Lightfastness	6 (blue scale) UNI EN ISO 105-B02
Fastness to rubbing	4/5 UNI EN ISO 105-X12
Pilling	5 UNI EN ISO 12945-2
Acoustic performances	0,6 ISO 354
Fire tests	UNI 9174 - 8456 Class C1 · UNI 9175 Class 1 IM · DIN 4102 Class B1 · NF 92501-7 Class M1 · NF D 60013 · Class AM18 · EN 1021-1 & 2 · BS Crib 5 · BS 7176 · Class Medium Hazard EN 13773 Class 1 OENORM · 3800-1 Class B1,Q1,TR1 · California TB117 · USA NFPA 701 · USA NFPA 260 · IMO Part 8 Upholstery

## Color Shades

---



Rice Cake  
F01