

Il Colonnato, Assembly guide

kettal

Il Colonnato,
Dining table 280 x 140
Assembly instructions

kettal

Il Colonnato, Dining table 280 x 140

Description

In this project, Mario Bellini took his inspiration from a basic elemental structure in architecture. His design emulated the colonnade of classical architecture, in which a sequence of columns supports a portico, in this case a table top. The base is a visually closed volume, despite being materially open. When seen from a different viewpoint, perception changes completely, as the columns no longer overlap and the space appears empty.

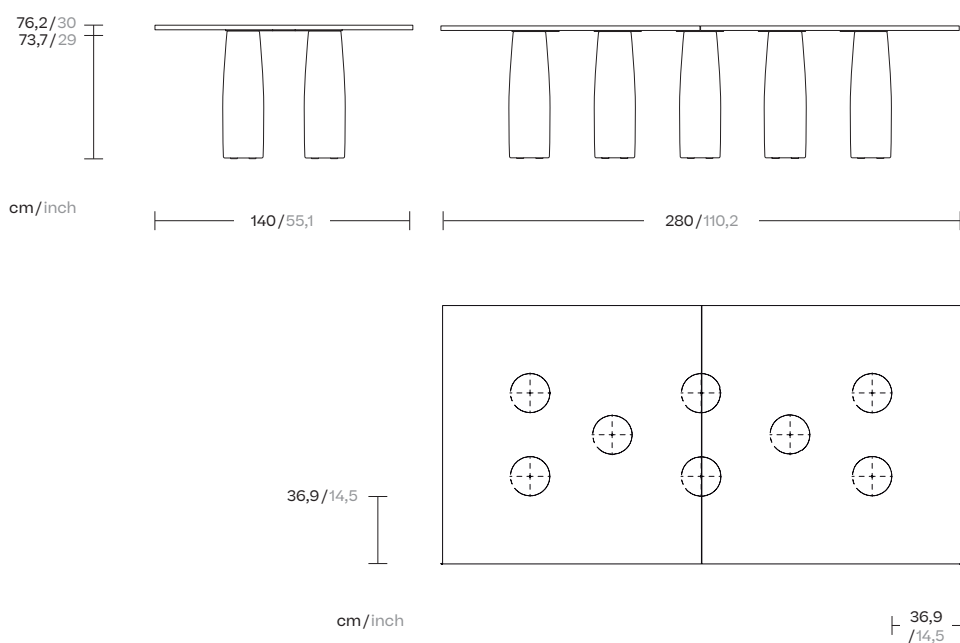

Information

Cleaning Instructions

Use a soft damp cloth, with soap or neutral detergent.
Do not use alcohol or other solvents.

This symbol on the product or its packaging indicates that it must not be treated as household waste. It should, in fact, be handed in at a recognised collection point for recycling electrical and electronic equipment. For more detailed information about the recycling of this product, please contact your local city office, your household waste disposal service or the shop where you purchased the product.

This product is suitable for indoor and outdoor.

Elements

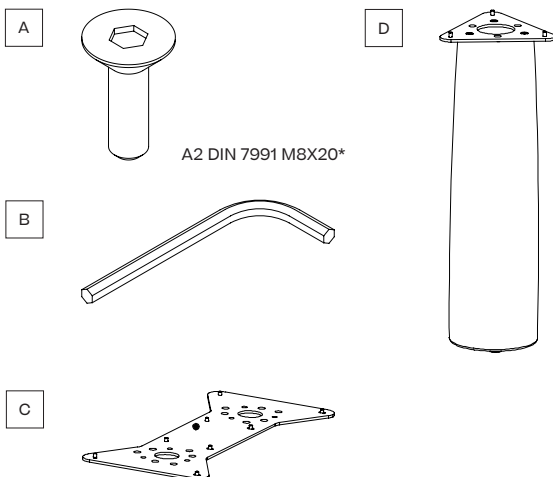

* For Marble and Travertine, M6X20
* For Teak and Concrete, M8X20

Warning

It is not recommended to lift the table once the legs are fixed to the top. If you want to change the place of the table, it is advisable to completely disassemble it and install it in the new location, following the procedure described.

We do not recommend climbing on top of the table, as it can be damaged.

It is important to never lift/handle/move tables with the legs assembled to the tops.

If the tables are moved assembled, this can cause stresses on the inserts, and can create cracks.

If the tables need to be lifted/handled/moved, it is necessary to disassemble it, by removing the legs from the top.

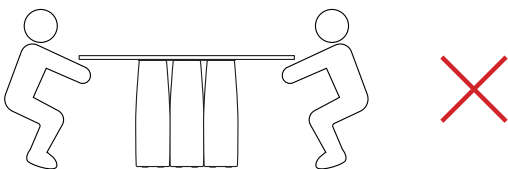

The packed top must always be handled and transported vertically, the tops must never be transported horizontally.

The tops should never be handled or lifted from the extremities.

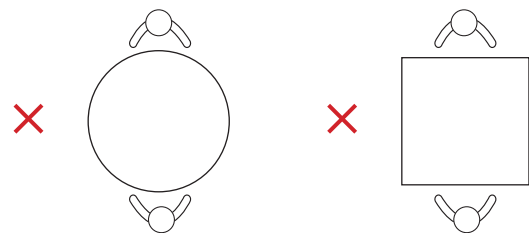

Always handle the top in more than two people, located at equidistant points.

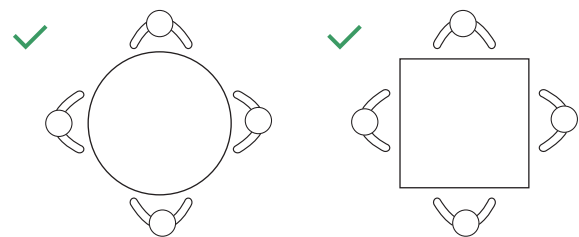

Do not cover the table with cloths or covers, in order to repair it from rain, snow, low temperatures. This operation will damage the surface and will create spots, which cannot be removed easily.

Il Colonnato, Dining table 280 x 140

Template sheet legend

For the assembly of Dining table 280 x 140, break the "A" holes
For the assembly of Dining table 140 x 140, break the "B" holes

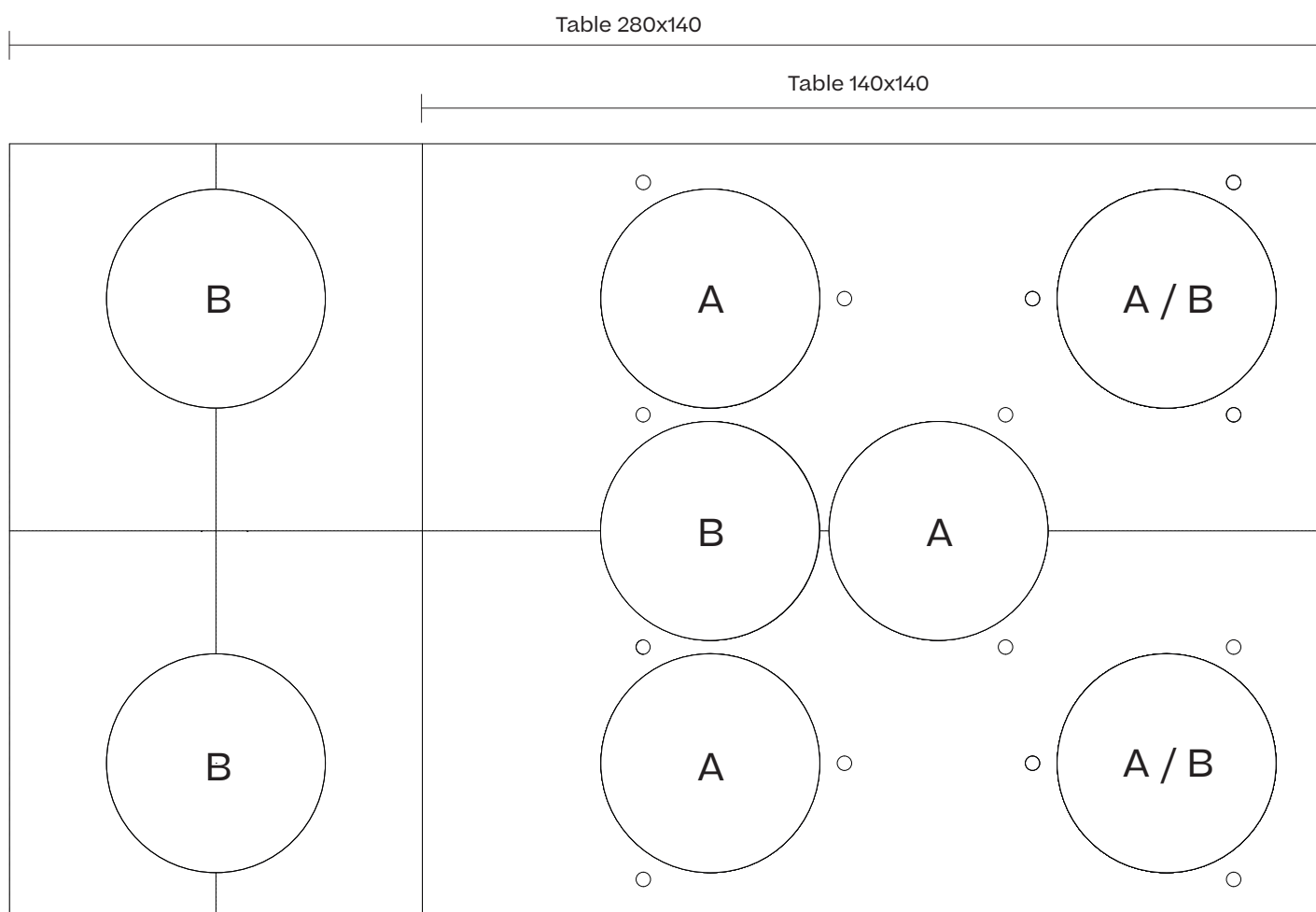

- 1 Place the sheets on the ground matching the two central holes of each template

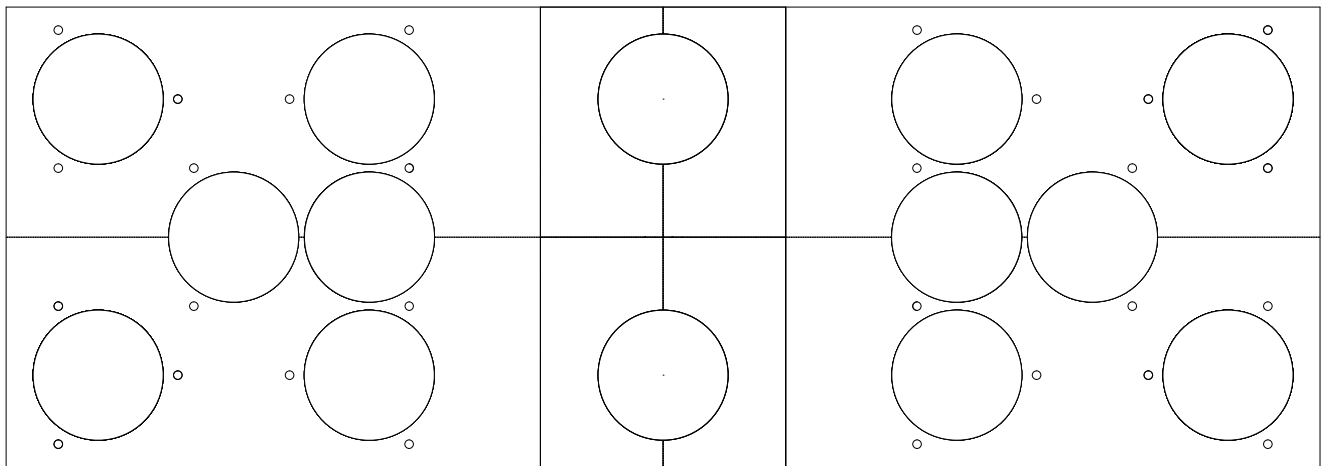

- 2 Place the legs in the bold positions

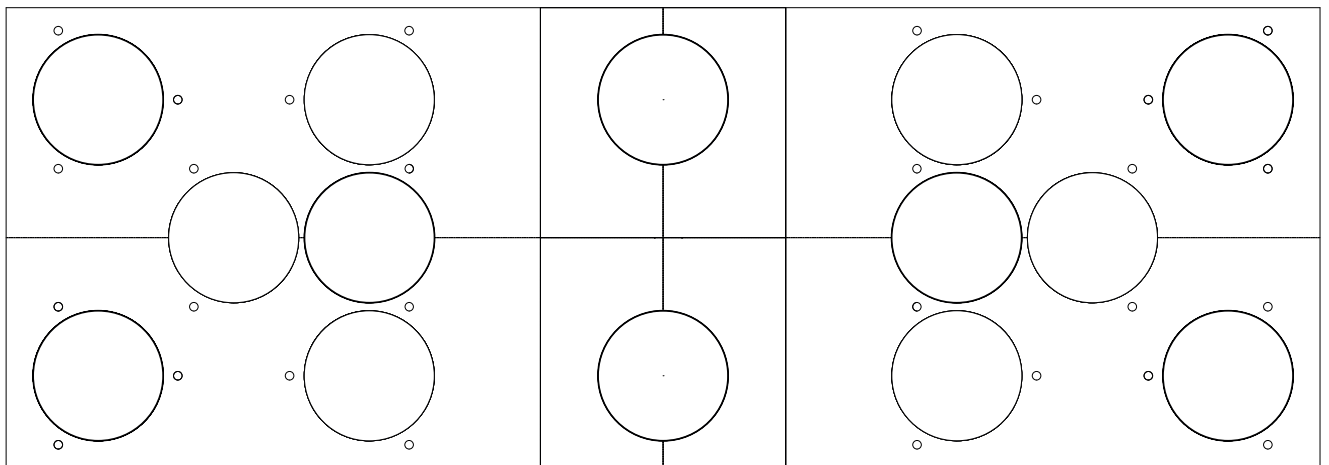

Il Colonnato, Dining table 280 x 140

- 3 Once all the legs are placed, rotate them until they align with the small holes in the templates.

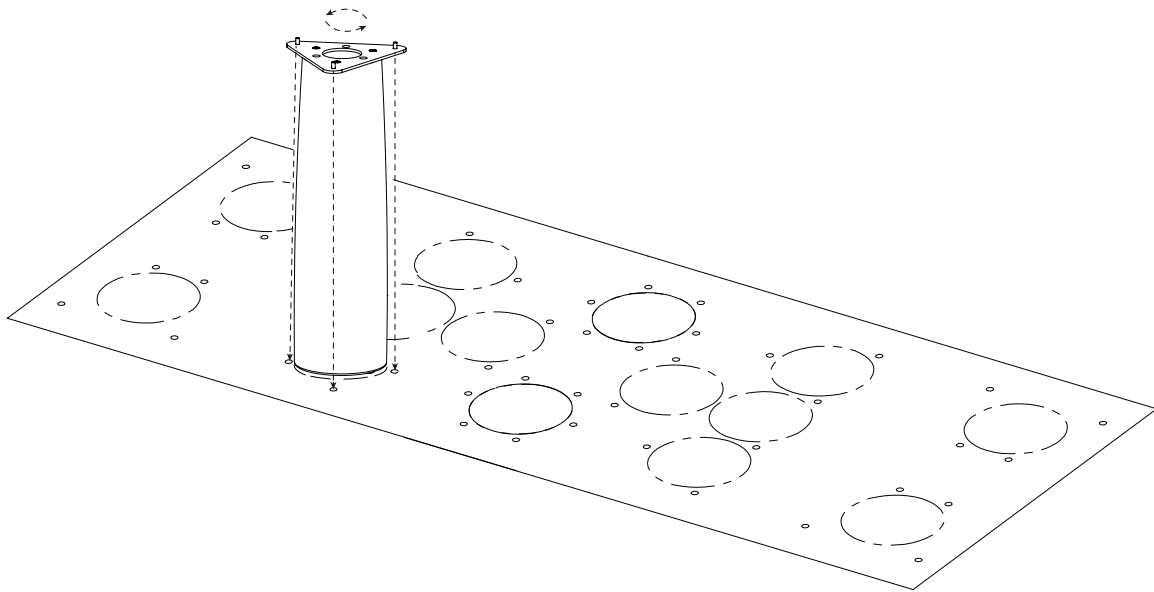

- 4 Unscrew the center leg plates and screw on the dual mounting kit.

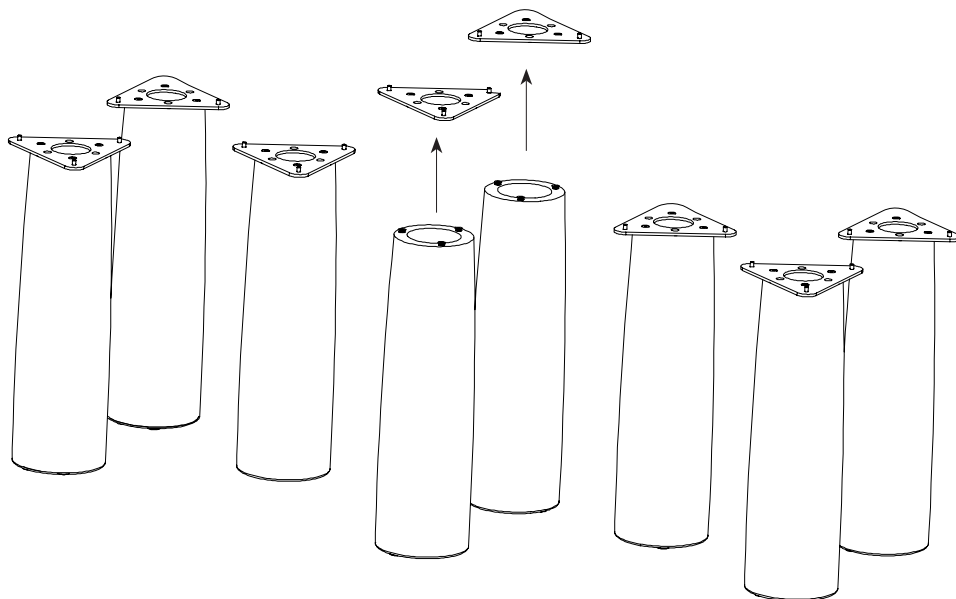

- 5 Screw on the dual mountin kit on the central plates

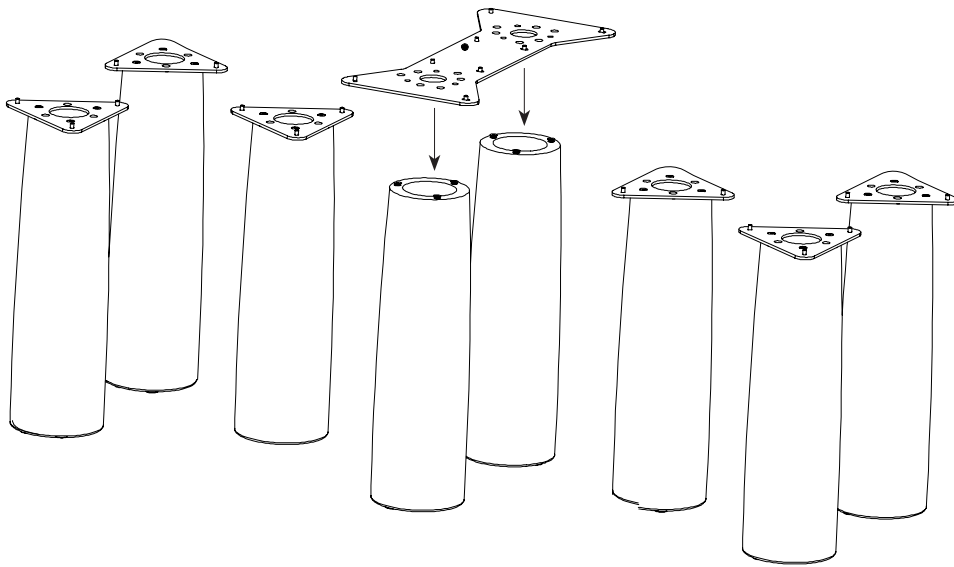

- 6 Finally, place one of the table tops above the legs and screw it. Then, do the same with the other table top.

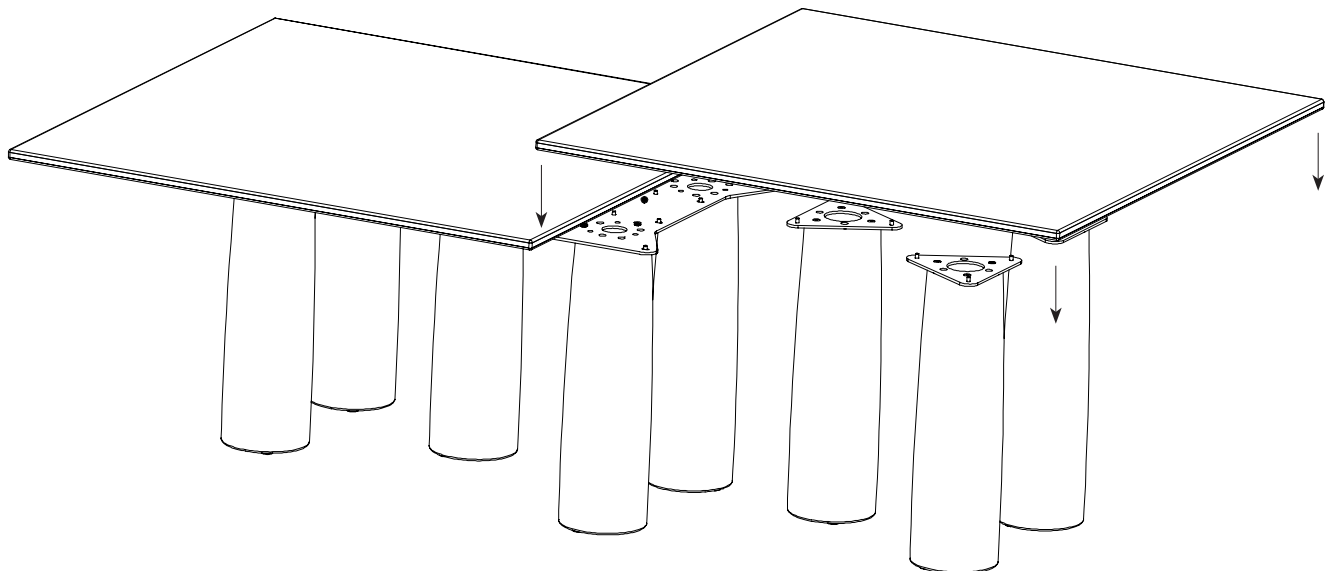

Il Colonnato, Dining table 280 x 140

Final result:

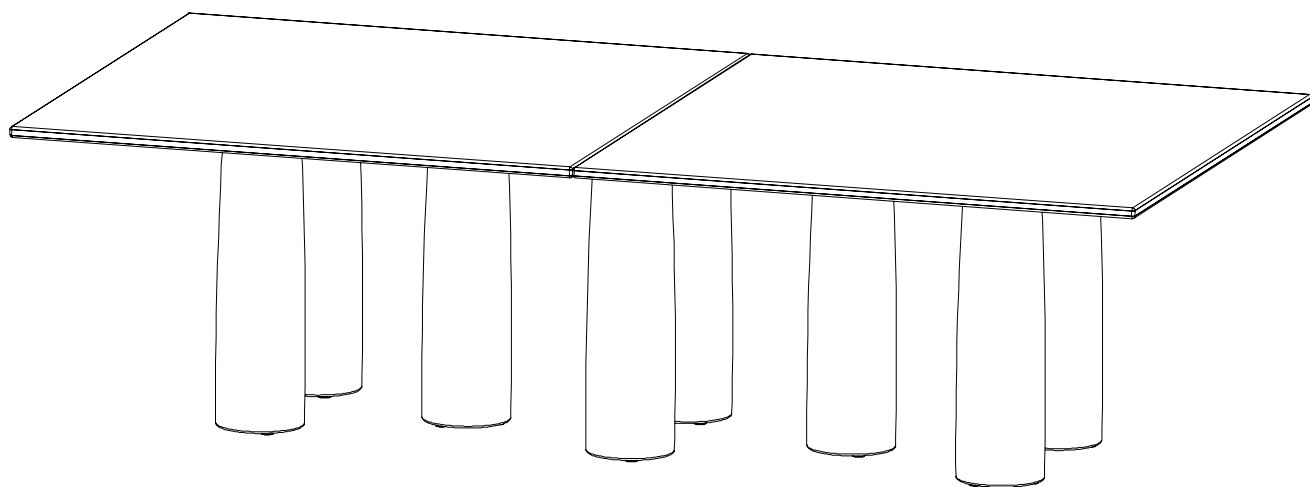

Il Colonnato,
Dining table 140 x 140
Assembly instructions

kettal

Il Colonnato, Dining table 140 x 140

Description

In this project, Mario Bellini took his inspiration from a basic elemental structure in architecture. His design emulated the colonnade of classical architecture, in which a sequence of columns supports a portico, in this case a table top. The base is a visually closed volume, despite being materially open. When seen from a different viewpoint, perception changes completely, as the columns no longer overlap and the space appears empty.

cm/inch

76,2/30
73,7/29

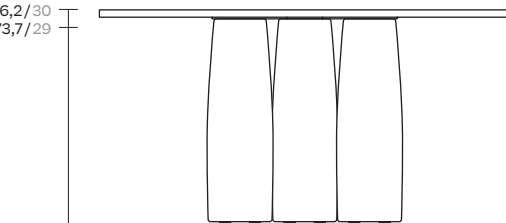

cm/inch

140/55,1

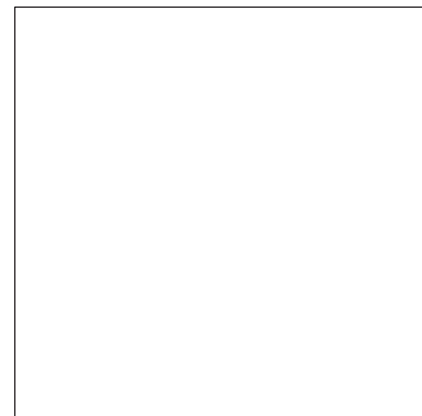

140/55,1



Information

Cleaning Instructions

Use a soft damp cloth, with soap or neutral detergent.
Do not use alcohol or other solvents.

This symbol on the product or its packaging indicates that it must not be treated as household waste. It should, in fact, be handed in at a recognised collection point for recycling electrical and electronic equipment. For more detailed information about the recycling of this product, please contact your local city office, your household waste disposal service or the shop where you purchased the product.

This product is suitable for indoor and outdoor.

Warning

It is not recommended to lift the table once the legs are fixed to the top. If you want to change the place of the table, it is advisable to completely disassemble it and install it in the new location, following the procedure described.

We do not recommend climbing on top of the table, as it can be damaged.

Elements

A

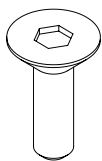

A2 DIN 7991 M8X20*

B



C

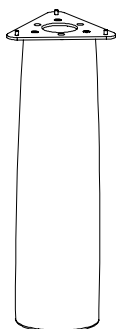

* For Marble and Travertine, M6X20

* For Teak and Concrete, M8X20

Warning

It is not recommended to lift the table once the legs are fixed to the top. If you want to change the place of the table, it is advisable to completely disassemble it and install it in the new location, following the procedure described.

We do not recommend climbing on top of the table, as it can be damaged.

It is important to never lift/handle/move tables with the legs assembled to the tops.

If the tables are moved assembled, this can cause stresses on the inserts, and can create cracks.

If the tables need to be lifted/handled/moved, it is necessary to disassemble it, by removing the legs from the top.

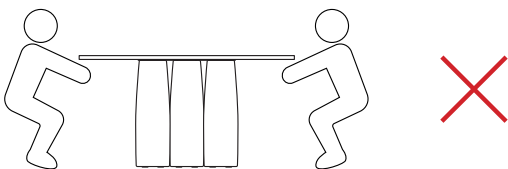

The packed top must always be handled and transported vertically, the tops must never be transported horizontally.

The tops should never be handled or lifted from the extremities.

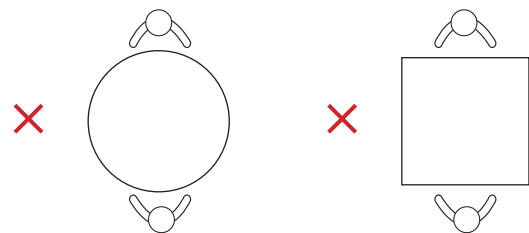

Always handle the top in more than two people, located at equidistant points.

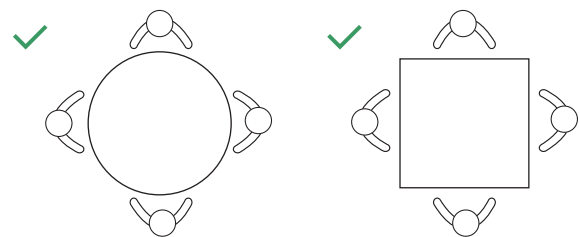

Do not cover the table with cloths or covers, in order to repair it from rain, snow, low temperatures. This operation will damage the surface and will create spots, which cannot be removed easily.

Il Colonnato, Dining table 140 x 140

Template sheet legend

For the assembly of Dining table 280 x 140, break the "A" holes
For the assembly of Dining table 140 x 140, break the "B" holes

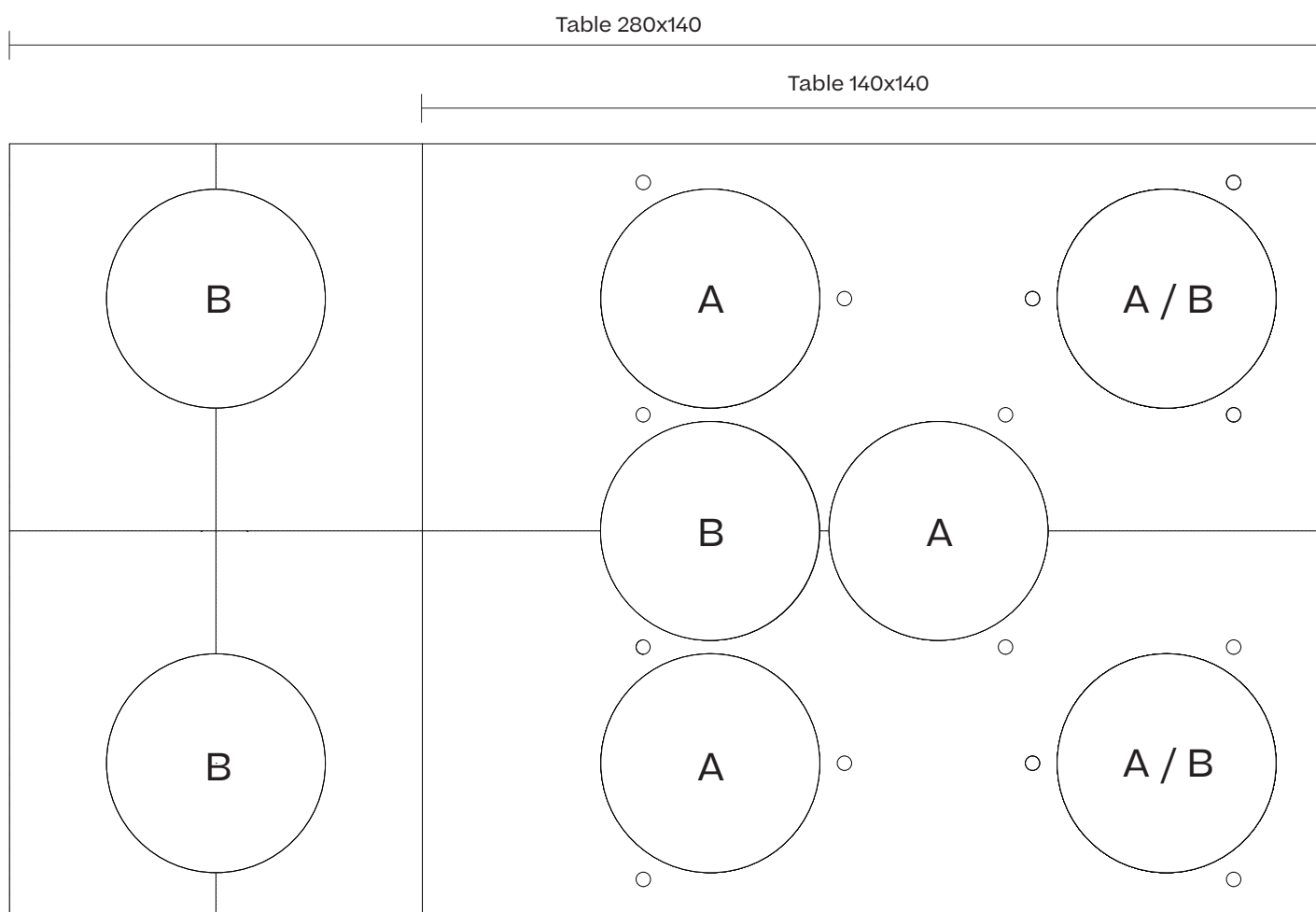

- 1 Place the template sheet on the ground and place the legs in the bold positions

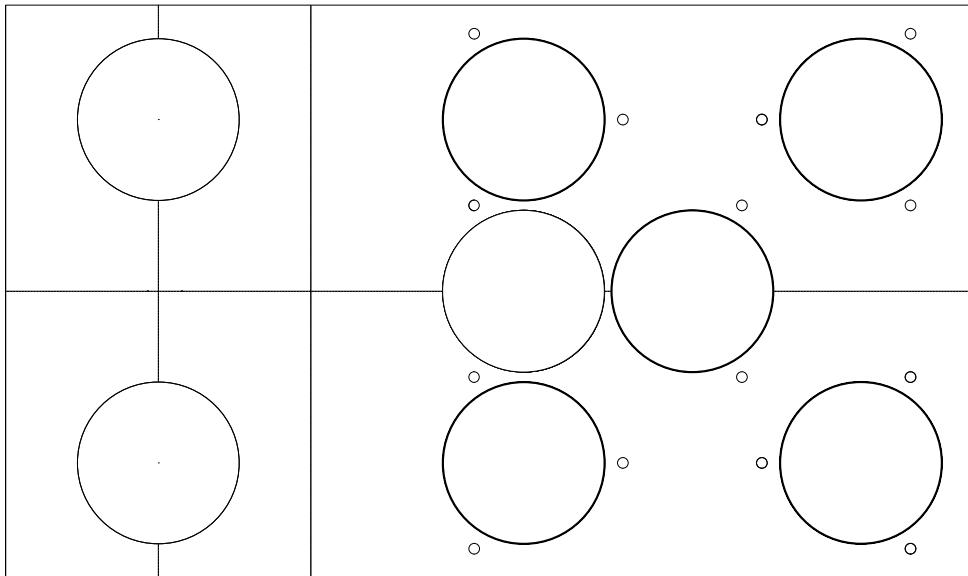

- 2 Once all the legs are placed, rotate them until they align with the small holes in the templates.

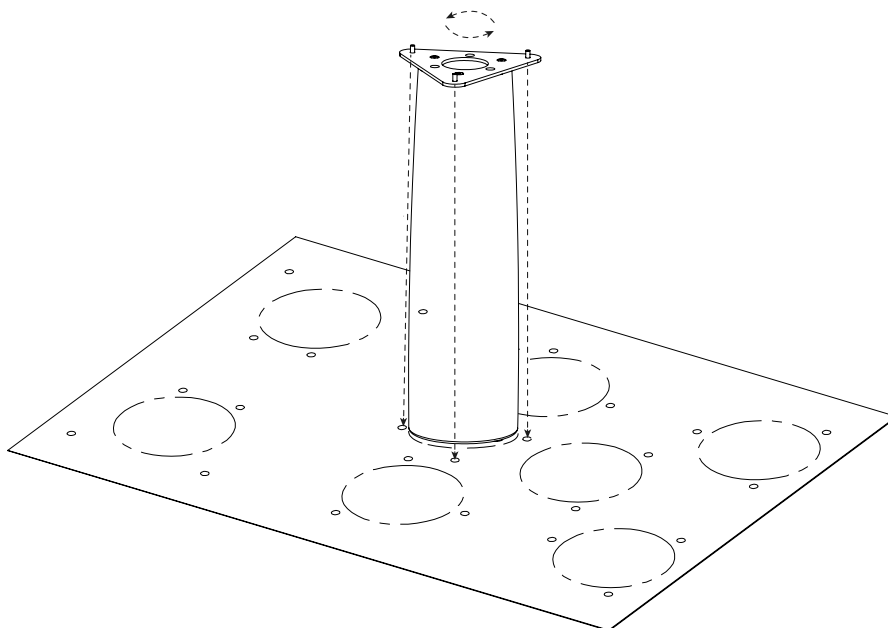

Il Colonnato, Dining table 140 x 140

- 3 Finally, place the table top above the legs and screw it.

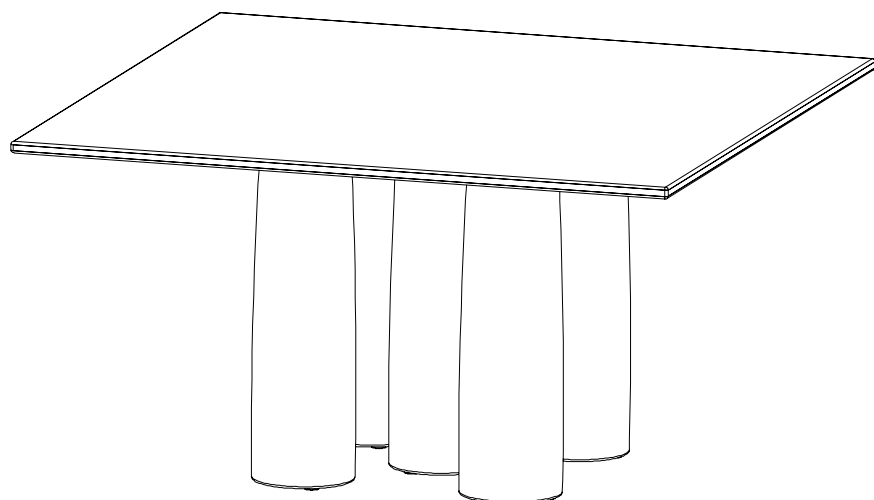
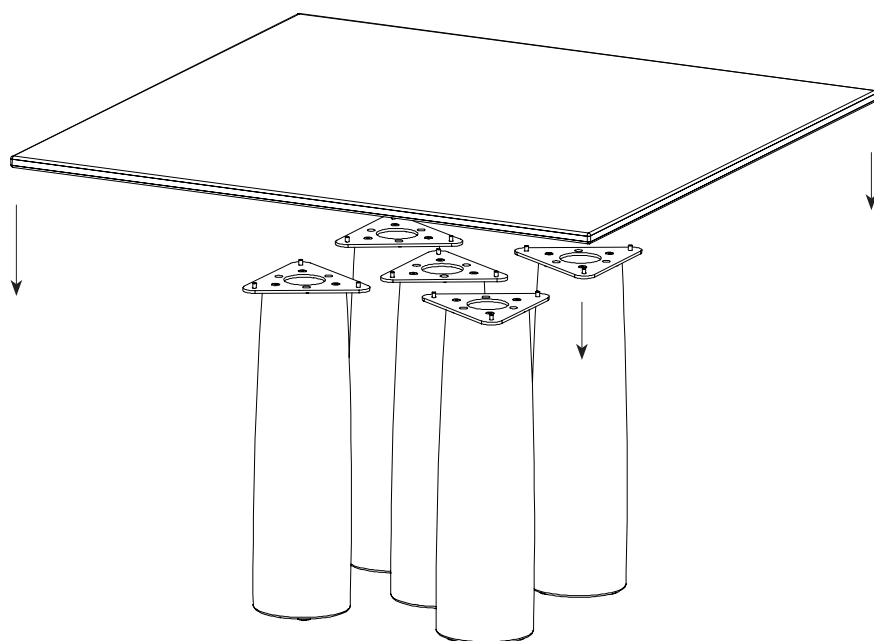

Il Colonnato,
Dining table Ø165
Assembly instructions

kettal

Il Colonnato, Dining table Ø165

Description

In this project, Mario Bellini took his inspiration from a basic elemental structure in architecture. His design emulated the colonnade of classical architecture, in which a sequence of columns supports a portico, in this case a table top. The base is a visually closed volume, despite being materially open. When seen from a different viewpoint, perception changes completely, as the columns no longer overlap and the space appears empty.

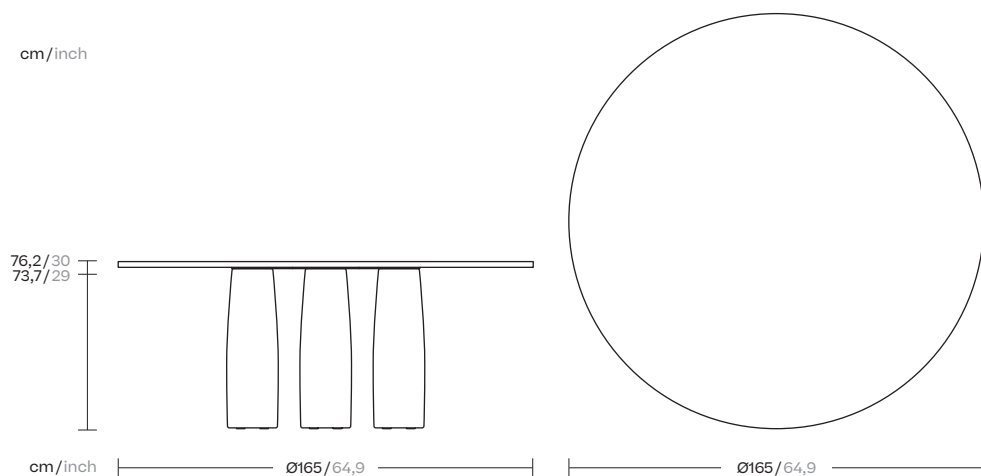

Information

Cleaning Instructions

Use a soft damp cloth, with soap or neutral detergent.
Do not use alcohol or other solvents.

This symbol on the product or its packaging indicates that it must not be treated as household waste. It should, in fact, be handed in at a recognised collection point for recycling electrical and electronic equipment. For more detailed information about the recycling of this product, please contact your local city office, your household waste disposal service or the shop where you purchased the product.

This product is suitable for indoor and outdoor.

Warning

It is not recommended to lift the table once the legs are fixed to the top. If you want to change the place of the table, it is advisable to completely disassemble it and install it in the new location, following the procedure described.

We do not recommend climbing on top of the table, as it can be damaged.

Elements

A

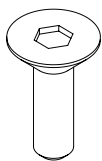

A2 DIN 7991 M8X20*

B



C

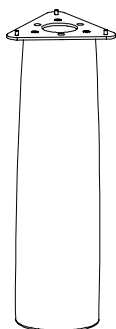

* For Marble and Travertine, M6X20

* For Teak and Concrete, M8X20

Warning

It is not recommended to lift the table once the legs are fixed to the top. If you want to change the place of the table, it is advisable to completely disassemble it and install it in the new location, following the procedure described.

We do not recommend climbing on top of the table, as it can be damaged.

It is important to never lift/handle/move tables with the legs assembled to the tops.

If the tables are moved assembled, this can cause stresses on the inserts, and can create cracks.

If the tables need to be lifted/handled/moved, it is necessary to disassemble it, by removing the legs from the top.

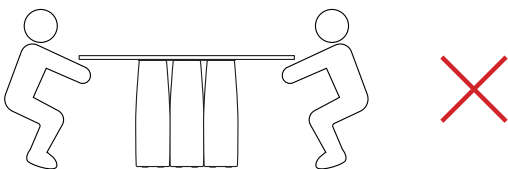

The packed top must always be handled and transported vertically, the tops must never be transported horizontally.

The tops should never be handled or lifted from the extremities.

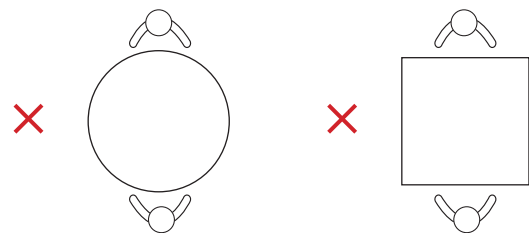

Always handle the top in more than two people, located at equidistant points.

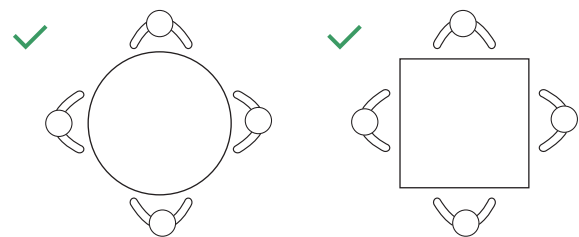

Do not cover the table with cloths or covers, in order to repair it from rain, snow, low temperatures. This operation will damage the surface and will create spots, which cannot be removed easily.

Il Colonnato, Dining table Ø165

- 1 Break the template holes, place the template sheet on the ground and put the legs in the round positions

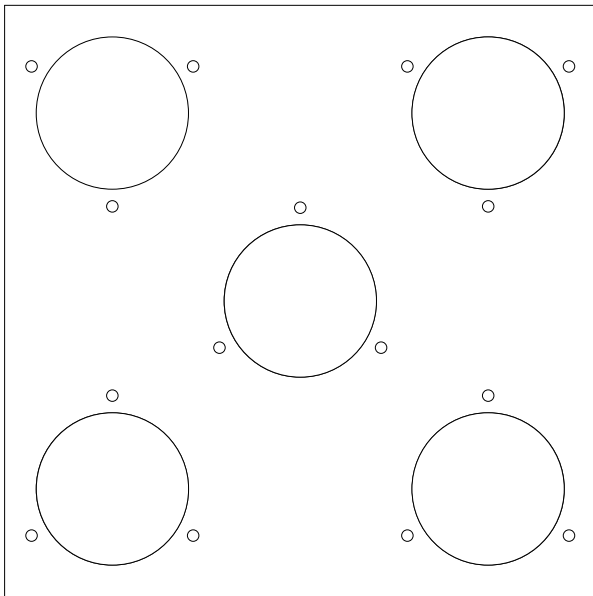

- 2 Once all the legs are placed, rotate them until they align with the small holes in the templates.

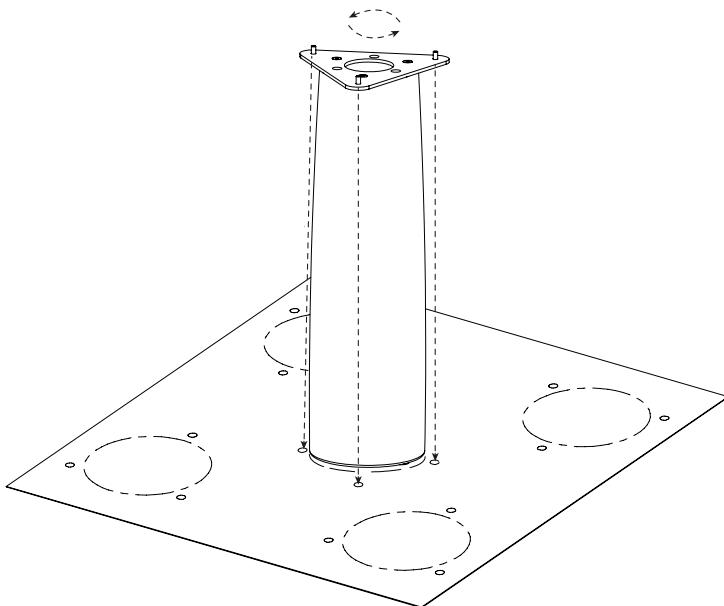

- 3 Finally, place the table top above the legs and screw it.

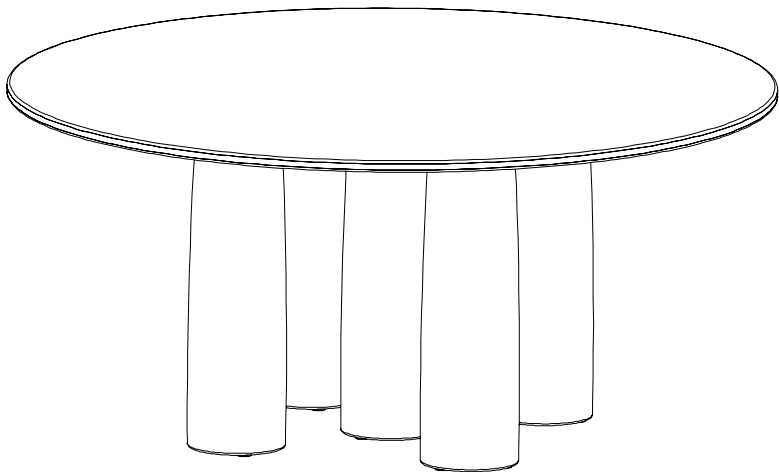
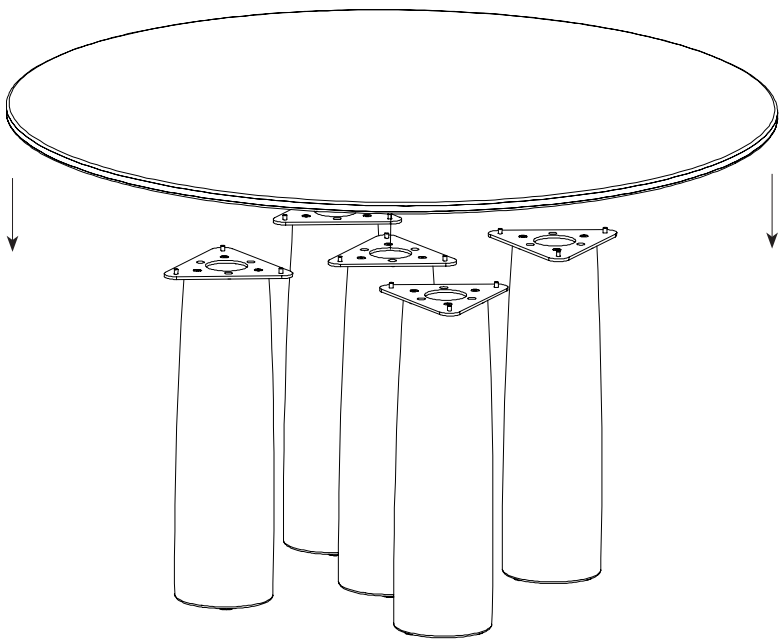

kettal