

Altar

Dining table,
by Miguel Milá

kettal

Dining table

Designer
Miguel Milá

Collection
Altar

Reference
KSA400100

1/3

Miguel Milá designed this table in the mid-sixties as an altar for his wedding. It later became a table for everyday use, but was never produced.

As if he were a master craftsman, Miguel Milá designed this piece based on the heart of simplicity and efficiency. Its shape hides its complexity, but at the same time reveals the wood's own character, giving it life and prominence. Its constructive logic makes it strong enough in terms of structure, but formally a beautiful piece.

The beauty of logic and common sense understands neither time nor trend.

cm/inch

74/29,1

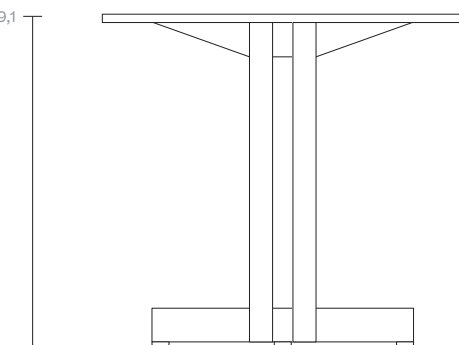

cm/inch

70/27,5

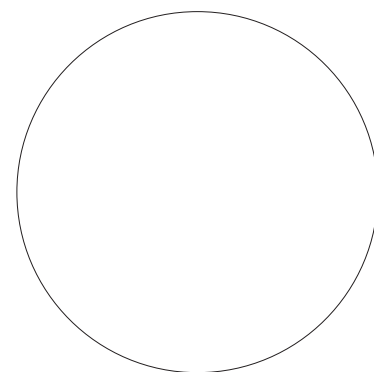

90/35,4



kettal

Dining table

Designer
Miguel Milá

Collection
Altar

Reference
KSA400100

2/3

Materials

Teak
Eco-friendly, A-grade

Aluminium
Antioxy, Heavy Load, Resistant
En-1421, Kettalize-It, Anti-
Scratch, Easy Clean, Flame
Retardant M1, Eco Friendly
Ecoembes Recycling Process

Marble
Antioxy, Mold resistant, Easy
Clean, Resist U.V., X-Temperature

Maintenance

Clean with mild soap using
sponge or cloth. Be gentle
while cleaning, do not scrub
aggressively the fabric. Once
cleaned please make sure you
remove soap excess.

In case of aggressive stains
clean with diluted household
bleach.

Clean stains promptly. The
longer it remains, more difficult
will be to remove.

Once cleaned the fabric steam
iron the fabric. Just use steam,
be carefull NOT placing the
iron directly in the fabric it will
get damage.

Table Top Colour



Slate Stone
01C



Mysty Smoke
02C



Ash
03C



Bone
04C



Tuff
05C

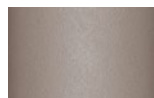

Wet Stone
06C



Sand Dune
07C

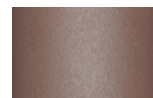

Dry Clay
08C

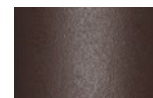

Arabica
09C



Sepia
19C



Rose Canyon
16C



Blossom
20C



Ruby Dust
18C



Sunset Glow
17C



Terrarosa
15C



Terracota
14C



Amber
13C



Ginger Root
12C

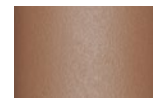

Desert Storm
11C



African Savannah
10C



Spring Meadow
28C



Kombu
29C



Forest Stream
27C



Sea Moss
26C



Glacier Ice
25C



Polar Sky
24C



Nightfall
23C



Indigo
22C



Wild Lupin
21C



Galena
33C



Bronze
30C



Corten
31C



Manganese
32C

Table Top Colour

Teak



Teak
904

Dining table

Designer
Miguel Milá

Collection
Altar

Reference
KSA400100

3/3

Other Characteristics

 Adjustable legs

Table Top Options

Aluminium 80 x 80
Aluminium Ø80
Glaze 80 x 80
Teak 80 x 80 contract (Untreated)
Teak ø80 contract (Untreated)

Table Top Colour

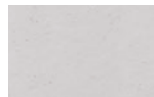

Dolomite
373



Indian Sapphire
371



Montana
377



Erinite
376



Black Diamond
374



Smoky Quartz
370



Jasper
375



Obsidian
372

Table Top Colour



Teak
(Untreated)

Teak

Legs Finish



Wood
(Untreated)

Wood