

Superfan,
Ceiling fan downrod
by Michael Anastassiades

kettal

Ceiling fan downrod

Designer
Michael Anastassiades

Collection
Superfan

Reference
KSA900200

1/5

cm/inch

Superfan is a tri-blade fan whose geometry is simply defined through three angled blades, meeting at the rotating axis.

All design decisions are made to maximise performance and improve efficiency: the angle of the blades, the lightness of the aluminium material and the selection of the motor for accurate speed control and quiet function.

The two fan versions operate with equal efficiency both with and without a pendant, offering flexibility of use for different ceiling heights.

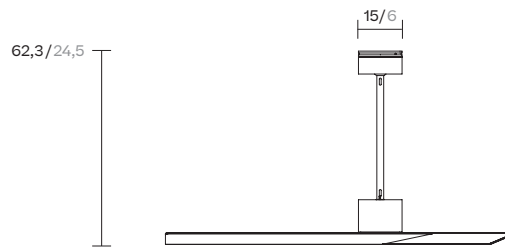

cm/inch

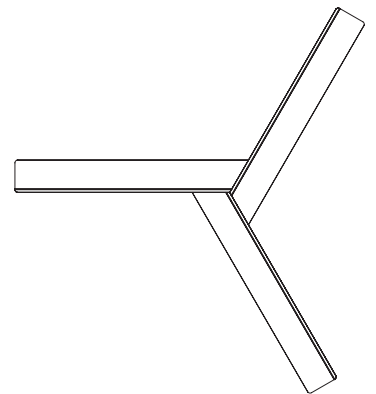

140/55,1

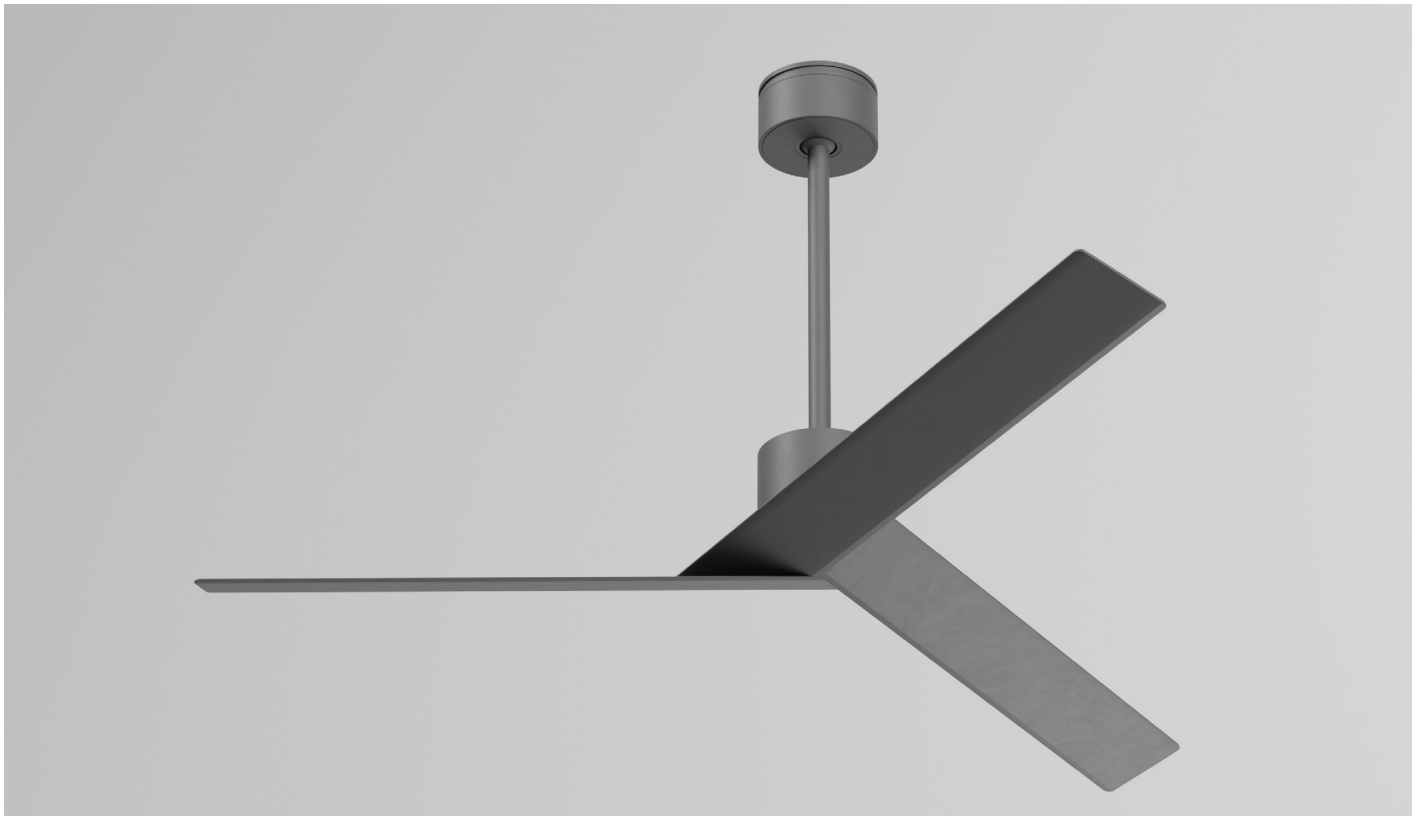

kettal

Ceiling fan downrod

Designer
Michael Anastassiades

Collection
Superfan

Reference
KSA900200

2/5

Technical info

Fixation	Ceiling
Engine type	Super silence motor BLDC (brushless direct current)
No. of speeds	6-speed selection
IP	44
Voltage	220-240V 110-120V (USA)
Hertz	50Hz 60Hz (USA)
Weight	7,5 kg (16,5 lbs). It must be installed on a structure capable of supporting 30kg (66lbs)
Max. Power consumption	Less than 35W
RPM	up to 130 rpm
Type of control included	Remote control / Fan reverse function control
No. of blades	3
Body/Structure	Aluminium

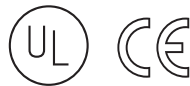

Warning

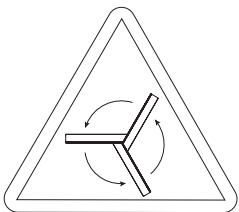

Rotating fan blades.

Can cause serious injury or cut.

Keep hands clear.

Safety stop. If something gets in the way of the blades, the fan stops

Ceiling fan downrod

Designer
Michael Anastassiades

Collection
Superfan

Reference
KSA900200

3/5

Ceiling height

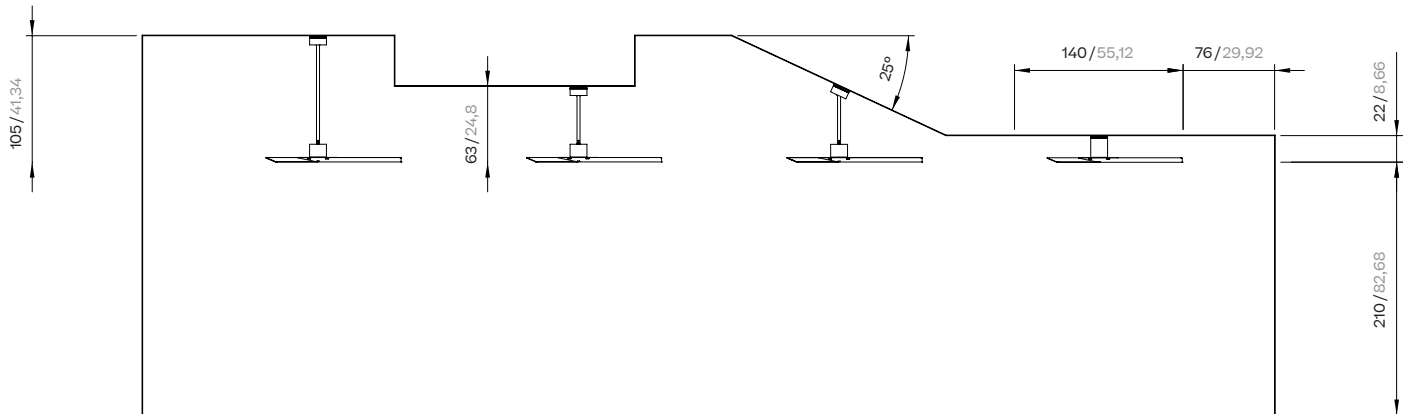

cm/inch

Fan location

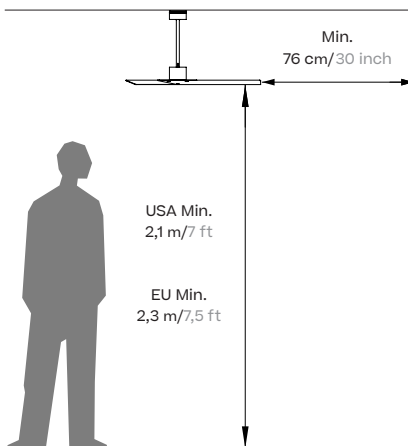

Allow a minimum clearance of 2,1 m (7 ft) for USA and 2,3 m (7,5 ft) for Europe from the floor to the blades and 30 inches (76 cm) from the wall to the end of the blades.

kettal

Ceiling fan downrod

Designer
Michael Anastassiades

Collection
Superfan

Reference
KSA900200

4/5

Materials

Aluminium
Antioxy, Heavy Load, Resistant
En-1421, Kettalize-It, Anti-
Scratch, Easy Clean, Flame
Retardant M1, Eco Friendly
Ecoembes Recycling Process

Includes remote control The
instalation requires a 220-240 2A
50/50Hz supply connection. The
client must

Maintenance

Clean with mild soap using
sponge or cloth. Be gentle
while cleaning, do not scrub
aggressively the fabric. Once
cleaned please make sure you
remove soap excess.

In case of aggressive stains
clean with diluted household
bleach.

Clean stains promptly. The
longer it remains, more difficult
will be to remove.

Once cleaned the fabric steam
iron the fabric. Just use steam,
be carefull NOT placing the
iron directly in the fabric it will
get damage.

Frame Colour Options

Terrain Coatings

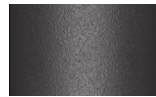

Slate Stone
01C



Mysty Smoke
02C



Ash
03C



Bone
04C

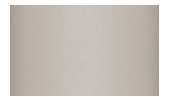

Tuff
05C



Wet Stone
06C



Sand Dune
07C



Dry Clay
08C



Arabica
09C



Sepia
19C



Rose Canyon
16C



Blossom
20C



Ruby Dust
18C



Sunset Glow
17C



Terrarosa
15C



Terracota
14C



Amber
13C



Ginger Root
12C



Desert Storm
11C



African Savannah
10C



Spring Meadow
28C

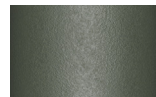

Kombu
29C



Forest Stream
27C



Sea Moss
26C



Glacier Ice
25C



Polar Sky
24C



Nightfall
23C



Indigo
22C



Wild Lupin
21C



Galena
33C



Bronze
30C



Corten
31C

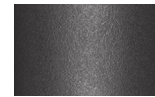

Manganese
32C

Ceiling fan downrod

Designer
Michael Anastassiades

Collection
Superfan

Reference
KSA900200

5/5

Colour Options

Aluwood



Atlantic White
Cedar
930



Western Red
Cedar
920



Smoked
Wenge
910