

Eolias,
Indoor Salina club
armchair with wheels
by Antonio Citterio

kettal

Indoor Salina club armchair with wheels

Designer
Antonio Citterio

Collection
Eolias

Reference
KSB200400

1/3

cm/inch

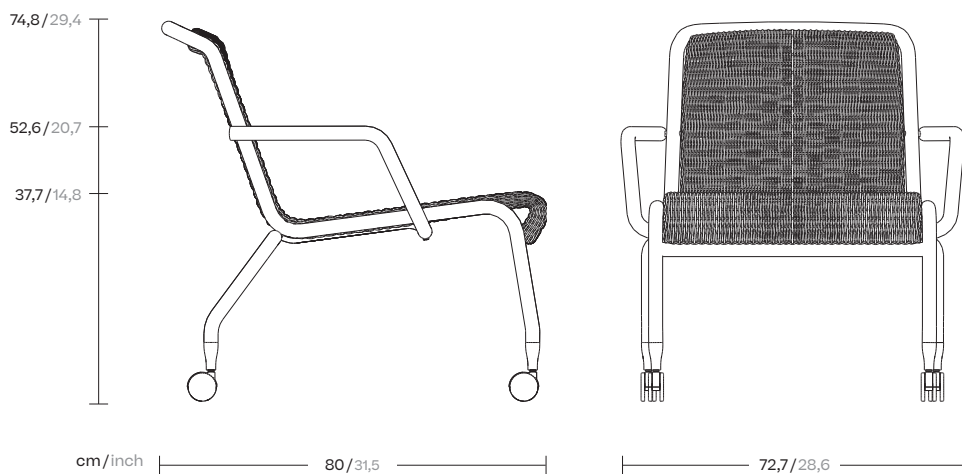

The Eolias collection by Kettal was born with the aim of creating versatile products, that work in both outdoor and indoor environments. The focus is on sustainability, thanks to the use of natural and synthetic materials such as aluminium and wicker.



kettal

Indoor Salina club armchair with wheels

Designer
Antonio Citterio

Collection
Eolias

Reference
KSB200400

2/3

Materials

Aluminium
Antioxy, Heavy Load, Resistant
En-1421, Kettalize-It, Anti-
Scratch, Easy Clean,
Flame Retardant M1, Eco Friendly
Ecoembes Recycling Process

Base Fabric
100% Polyester Trade Mark
Trevira CS

Leather

Bucket synthetic fiber braided

Structure Colour Options

Terrain Coatings

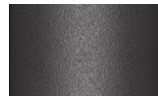

Slate Stone
01C



Mysty Smoke
02C



Ash
03C



Bone
04C



Tuff
05C



Wet Stone
06C



Sand Dune
07C



Dry Clay
08C



Arabica
09C



Sepia
19C



Rose Canyon
16C



Blossom
20C



Ruby Dust
18C



Sunset Glow
17C



Terrarosa
15C



Terracota
14C



Amber
13C



Ginger Root
12C



Desert Storm
11C



African Savannah
10C



Spring Meadow
28C

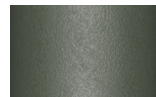

Kombu
29C



Forest Stream
27C



Sea Moss
26C



Glacier Ice
25C



Polar Sky
24C



Nightfall
23C



Indigo
22C



Wild Lupin
21C



Galena
33C



Bronze
30C



Corten
31C



Manganese
32C

Structure Colour Options

Terrain Lustre

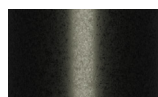

Noir d'Ivoire
CH2

Indoor Salina club armchair with wheels

Designer
Antonio Citterio

Collection
Eolias

Reference
KSB200400

3/3

Other Characteristics

 Indoor use only

 Stackable x2

 Wheels

Maintenance

Clean with mild soap using sponge or cloth. Be gentle while cleaning, do not scrub aggressively the fabric. Once cleaned please make sure you remove soap excess.

In case of aggressive stains clean with diluted household bleach.

Clean stains promptly. The longer it remains, more difficult will be to remove.

Once cleaned the fabric steam iron the fabric. Just use steam, be carefull NOT placing the iron directly in the fabric it will get damage.

Seat/Back Cushion



Rice Cake
F01



Toasted Almond
F02



Pecan Pie
F04



Indian Sunset
F05

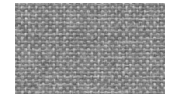

Stardew
F09



Orion Grey
F10

Base

Seat/Back Cushion

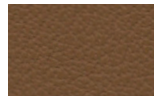

Tumbleweed
362



Kobicha
363

Leather

Piping Colour Options



Rosemary
MR1



Whole Clove
MR2



Mustard Grain
MR3



Sea Salt
MR4



Ground Pepper
MR5



Black Salt
MR6



Poppy Seed
MR7



Rose Harissa
MR8